

AeroDek Robust Plus Installation Instructions

OUR CONTACT DETAILS

If there is anything in this guide that you do not understand or that is unclear to you please do not hesitate to contact us on

Tel: 0330 12345 85 or

E: technical.redland@bmigroup.com

01. SAFETY

These instructions are illustrative only. For the sake of clarity, access equipment which should always be erected in accordance with safety regulations, has been omitted, as have safety helmets, roofing felt and sarking boards.

02. YOU NEED

Pencil

Tape measure or ruler

Tin snips

AeroDek hand nails* or AeroDek screws



You must only use fixing nails and screws supplied by AeroDek otherwise the AeroDek guarantee is invalidated

AeroDek roofing felt or breather membranes.

Soft soled safety shoes

Safety helmet

*AeroDek power nails are designed for use with a Paslode IM350 frame nailer gun.

03. YOU ALSO NEED

To cut the tiles and accessories you need;

AeroDek Tile Guillotine or alternatively a reciprocating saw or jigsaw (fitted with an appropriate AeroDek Cutting Blade).



Do not use angle grinders or disk cutting equipment

To form edge details to the perimeters of the roof you need;

AeroDek Tile Bender

AeroDek Tile Bender Attachment (for bending the full length of a tile)

IMPORTANT - Operatives are reminded to take all due care when handling sharp edges and using tools.

04. SETTING OUT THE FASCIA BOARDS AT EAVES

The positioning of the fascia board at the eaves is crucial to the success of the installation.

The fascia board must be set at the right height, set too low the tiles will dive, set too high the tiles will kick up at the wrong angle. The top edge of the fascia board should be set at the same height as the tile battens.

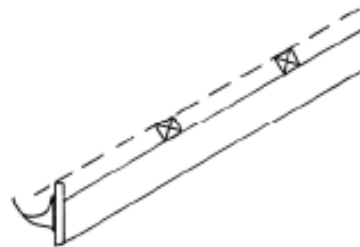

However if you are installing fascia mounted eave ventilators or AeroDek eaves guard your fascia board may need to be set lower. (refer to the instructions supplied in the AeroDek ventilation pack & AeroDek eaves guard



Unventilated

Ventilated

05. BATTENING

The most crucial factor in laying tiles is the accurate setting out of the tile battens, if you are not accurate then the tiles will not fit together properly.

Time spent taking extra care when battening is time saved when tiling.

BATTEN SIZE REQUIRED

Rafter Centre (mm)	Batten (recommended)
450	50 x 38 mm
600	50 x 38mm
900	50 x 50 mm
1200	50 x 50 mm

06. SETTING OUT THE BATTENS AT EAVES

The positioning of the first batten at the eaves is crucial to the success of the installation.

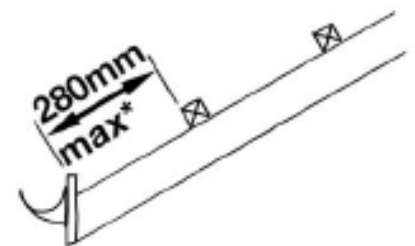

*The first tile batten should be placed in a position to suit the roof pitch and/or type of gutter, typically this is 280mm from the front edge of the fascia board to the front edge of the first tile batten.

However if you are installing fascia mounted eave ventilators refer to the instruction supplied in the AeroDek Ventillation pack.

07. BATTENING THE ROOF

Then fix the other battens working from the bottom of the rafter.

At 320mm spacings from front lower face of batten to front lower face of batten.

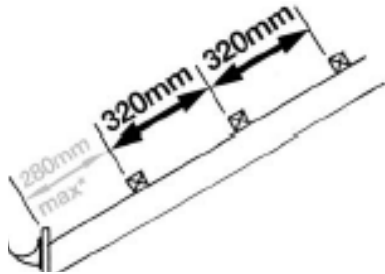

Care should be taken to be accurate when installing the battens. Time spent taking extra care when battening is time safe when tiling.

08. AERODEK EAVES GUARDS

AeroDek Eaves Guard is an eave protection system which is installed underneath the roofing underlay providing support for the underlay at eaves.



AeroDek Eaves Guard

The installation procedure for the AeroDek Eaves Guard varies according to roof pitch and rafter spacing. If you are installing the AeroDek Eaves Guard refer to the instructions supplied in the AeroDek Eaves Guard pack.

09. SETTING OUT GABLES

Fix the barge boards in a position where they are level with the tops of the tile battens. Underlay should turn up against the edge of bargeboard by 38mm.

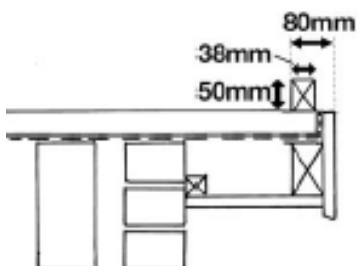

On top of the tile battens nail an additional 50mm x 38mm gable runner batten up the slope of the roof. This batten should be set 80mm in from the outer edge of the bargeboard (see drawing above).

10 WALKING ON THE TILES

When walking on the roof it is strongly recommended that you should wear soft soled safety shoes to avoid any possible abrasion to the surface coating.

Your weight should be concentrated over the front edge and in the pan of tiles, as this is the area supported by battens. Weight should not be applied to the raised crown of the profile on the middle tiles. **If you have managed to dent a tile refer to the tip section in this guide.**

11. START LAYING THE TILES

Lay the tiles starting at the batten below the ridge and next to the gable.

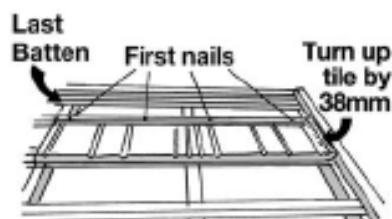

Why lay from the top?

Although this is the opposite of traditional tiling practice, by laying from the top the tiles interlock together and it is actually quicker to lay the tiles this way.

Cut the first row of tiles from the bargeboard into random widths so that the profile of the tile does not appear in the same vertical position. Form a 38mm upstand edge against the gable runner batten (see setting out gables section).

Do I lay the tiles straight bond or staggered bond?

Robust Plus tiles should always be laid staggered bond ensuring that a repeat pattern does not appear in the side overlap down the roof slope. For best appearance lay the laps away from the principle line of site of the building.

Starting from a gable end?

Then don't forget you may need to allow for an appropriate upstand at the gable end of the tile (see Gable sections).

How much side lap?

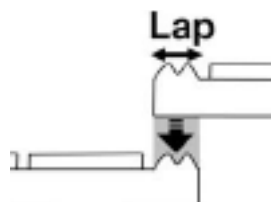

12. WHEN YOU HAVE LAID SEVERAL COURSES

When you have laid several courses (laying them one under the other, by lifting the nose of a tile and tucking the next tile under) Start nailing with AeroDek nails, 4 per tile.

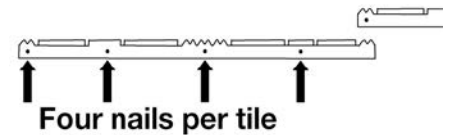

Tilt nail downwards for the best fit

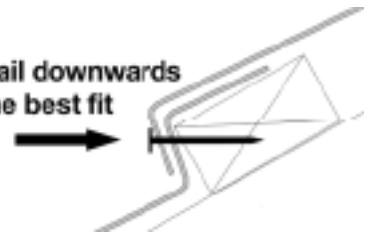

Nail tiles through the nose as shown in the sketches, leaving bottom course loose until more tiles are laid. One nailing point must be at lap of course below.

i You must only use fixing nails and screws supplied by AeroDek otherwise the AeroDek guarantee is invalidated

13. NAIL THE EAVES COURSE

Nail the eaves course at the high points of the tile surface into the top of fascia or eaves batten (if eaves ventilation is being fitted, see ventilation pack for nail positions).

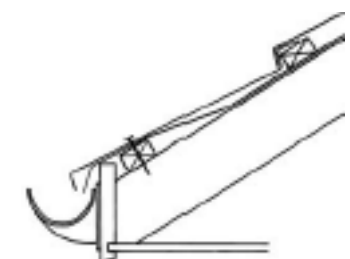
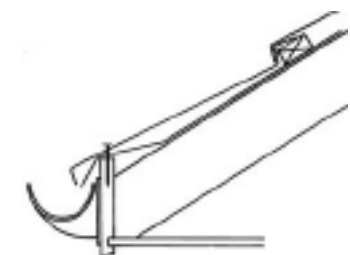

Use 4 nails per each tile.

After completion of the roof cover these nail heads with AeroDek finishing kit.

14. GABLES

Start off at the eaves by nailing an AeroDek Barge Cover Eave Closure into position (see image below). Fold lower half of front edge of barge cover back up and behind front lip of eaves tile (see grey shaded area on image below).

After completion of roof cover these nail heads with an AeroDek finishing kit.

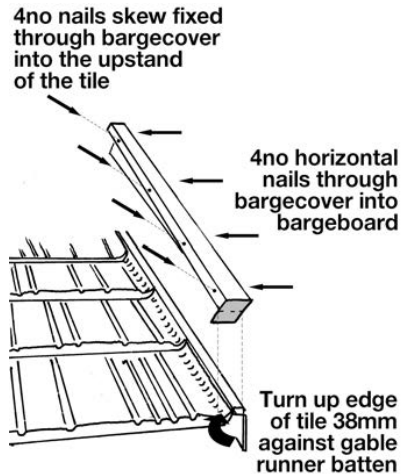

Nail remaining bargecovers into position using 4 nails skew fixed down the inner face of the bargecover into the upstand of the tile and 4 horizontally as before. Care should be taken to ensure bargecovers are correctly lapped.

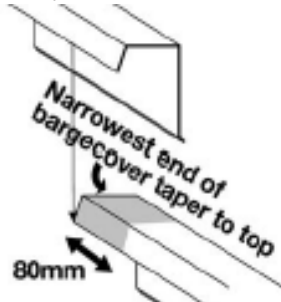

After completion of roof cover the bargecover nail heads with AeroDek finishing kit.

15. RIDGE COURSE D RIDGE

The correct way to install the top course of tiles and the ridge tiles is determined by whether you are trying to achieve an unventilated or ventilated ridge detail.



Universal ridge ventilator

16. PREPARATION OF THE TOP COURSE OF TILES

When you have cut and bent the tile you may find there is some natural distortion in the tile and it may look like the tile won't fit. This is perfectly normal.

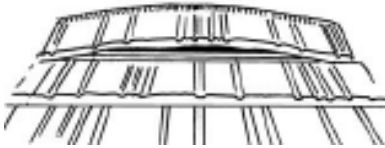

There is a standard procedure for removing any distortion. If this procedure is followed, installation is simple. If not followed it will be difficult to achieve a good fit.

Step 1

Do not try to squash the tile into position at this stage (wait until you have completed step 4).

Locate front corner of tile into the interlocking profile of tile below and nail this corner into position.

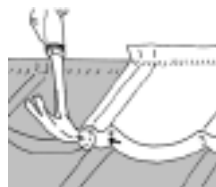

Step 2

Locate rear corner of tile into interlock of adjoining tile and nail this corner into position as appropriate.



Step 3

Locate other front corner of tile into interlock of tile below and nail this corner into position.

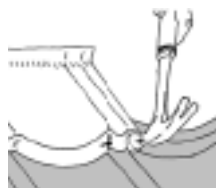

Step 4

Locate remaining rear corner of tile into position and nail as appropriate.



Step 5

Push front edge of tile into position and work your way into the middle nailing as you go.

17. RIDGE COURSE NAILING AND LAPPING D RIDGES

The ridge caps have a slight taper in their

design. Place the wider end of the ridge over the narrower end of the ridge beneath creating an 80mm overlap.

Each ridge should be secured with 4 nails on each side of the ridge cap.

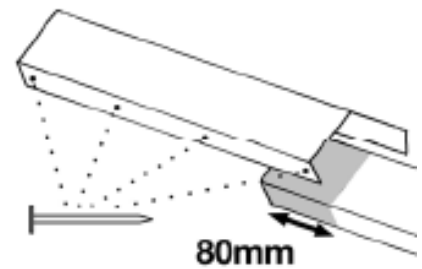

18. RIDGE COURSE D RIDGE (UNVENTILATED)

Fix two tile battens either side of ridge. Fix additional 50mm x 38mm batten to suit D Ridge on top of rear of the two tile battens.

Lay top course of tiles with back turned up 38mm.

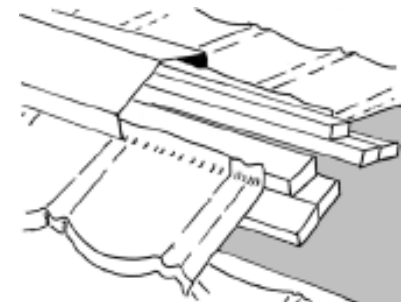

i For tips on cutting and bending tiles, see back of this guide

19. RIDGE COURSE D RIDGE WITH UNIVERSAL D RIDGE VENT



Universal ridge vent filler

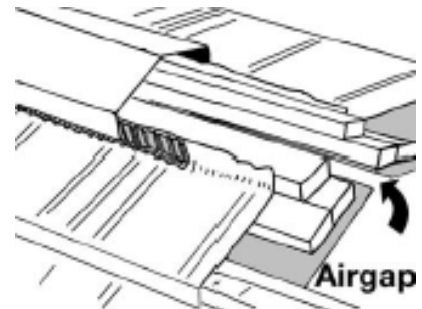

Cut underlay short of ridge line and fit two tile battens either side of ridge, leaving sufficient gap for ventilation.

Fix additional tile batten to suit ridge on top of rear of the two tile battens.

Lay top course of tiles with back turned up 38mm against top tile batten.

Place ridge cap into position over the top batten and the upstand edge of tile. Pull bottom away from the upstand edge of tiles and slip Universal D Ridge/hip ventilators into position on each side of the D ridge cap. Ventilators should run continuously along each side of the ridge cap.

The ridge cap and ventilator to be nailed through the downturn of the ridge cap into the face of the batten, using 4 AeroDek nails on each side.

i For tips on cutting and bending tiles, see back of this guide

20. D RIDGE END CAPS

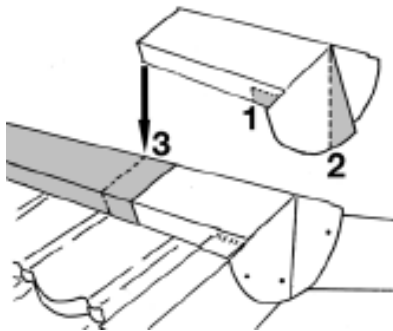

1. Snip and fold out flap to suit barge cover.
2. Trim edge of flap to create a vertical plumb line when fitted.
3. Install D Ridges over end of D Ridge End Cap ensuring good tight lap occurs. Then nail D Ridge End Cap into position (Fix vertical end of D Ridge End Cap first).

21. MONO-PITCH D RIDGE

Mono-pitch ridge caps can be formed by adjusting the angles of an AeroDek standard D Ridge cap.



The procedure for installing the monopitch ridge is essentially the same as the detail for the ridges (please refer to ridge instruction shown earlier in this guide).

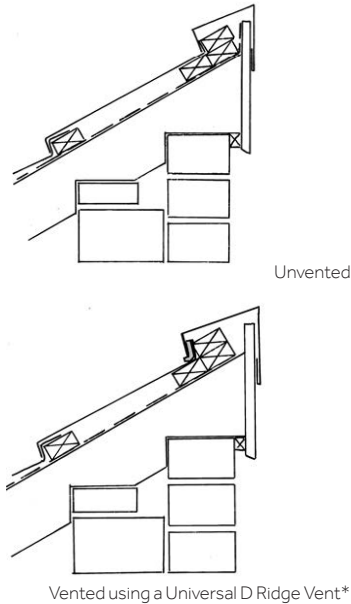

*When fitting the two tile battens at the top remember to leave a sufficient gap for ventilation.

*When fitting the D ridge ensure that a gap of at least 5mm is maintained between the underside of the ridge and the topmost batten.

i For tips on cutting and bending tiles, see back of this guide

22. TOP EDGE ABUTMENT

Unvented

Turn the tile (or an AeroDek Top Course flashing) and the roofing underlay 75mm up the abutment wall and cover over with a lead flashing.

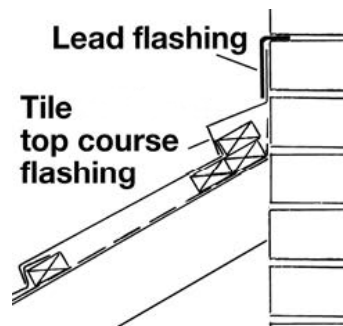

Vented with a Universal D Ridge Vent Filler

An appropriate top course flashing for use with an AeroDek Universal D ridge ventilator can be formed using an AeroDek Top Course flashing or alternatively by adjusting the angles of AeroDek's standard D Ridge cap. When fitting the top course flashing ensure that a gap of at least 5mm is maintained between the underside of the top course flashing and the topmost batten.

(When fitting the two tile battens at the top remember to leave a sufficient gap for ventilation)

For tips on cutting and bending tiles, see back of this guide.

23. SIDE EDGE ABUTMENT

Turn the tile and roofing underlay 75mm up the abutment wall and cover over with a lead flashing.

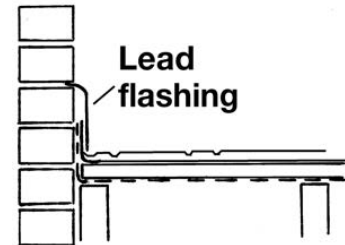

i For tips on cutting and bending tiles, see back of this guide

24. HIPS

Install tile battens to suit gauge of tiles, ensure that tile battens project to centre line of hip tree.

Install hip runner batten to each side of hip to suit width of hip cap component.

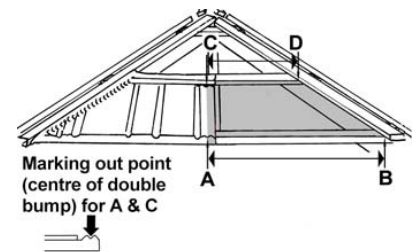

Step 1 Measuring for the Hip Tile

Measure from point (A) to (B), measure from point (C) to (D), write down these measurements as these will be the set distances to make your bend at.

Step 2 Marking out your Hip Tile

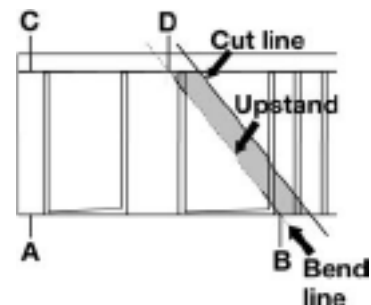

Markout the same measurement (A) to (B) and (C) to (D) on a tile. When transferring measurements to tile ensure measurement correspond with the position underlying tile batten.

Scribe a line from (B) to (D), this will be the bending point for your hip tile. Scribe an additional cut line on to the tile to allow for a tile upstand at the hip. This upstand should be sufficient to cover the hip runner batten (any excess in the upturn can be dressed over the top of the hip batten).

Step 3 Cut and bend your hip tile

For tips on cutting and bending tiles, see back of this guide.

Step 4 Install ridge cap to hip

The methods for installing AeroDek ridges with or without Universal D ridge ventilators is the same in principle as shown for the ridge detailing earlier in this guide.

NOTE: Pre-finished hip end closures are available for the foot of the hip.

25. FORMING A THREE WAY INTERSECTION AT HIPS

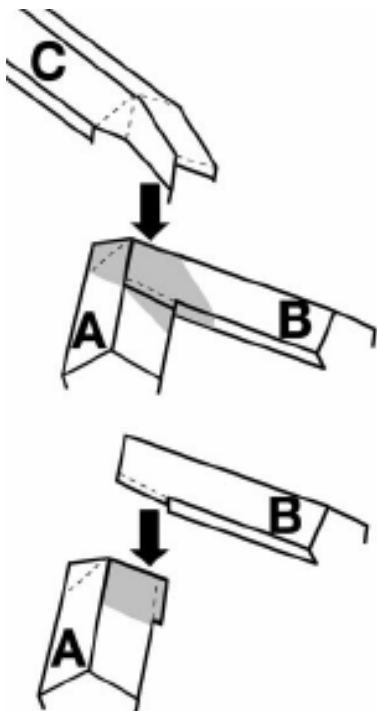

To form a three way intersection using D Ridges cut and fold tabs and flaps in ridge tiles as shown ridge sections A, B and C above. Install ridge section A followed by ridge section B then C on top. Nail ridge caps into position and touch up with AeroDek finishing kit.

26. VALLEYS

Lay valley boards flush with rafter level and install valley runner batten to each side of the valley.

If needed install an additional packer batten, parallel to side of valley runner batten, so as to support sweep of tile batten.

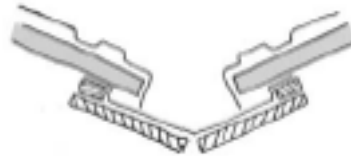

Install tile battens to suit gauge of tiles, ensure that the tile battens sweep up and over valley runner batten. Cut battens to rake projecting over valley to 65mm short of centre line of valley.



For measuring, marking out, cutting and bending valley tiles follow the same procedure as the hips (refer to hip section). But form a downturn in the valley tile rather than an upstand.

NOTE: When forming a downturn in the tile take a measurement from top of leading edge of tile batten to valley surface and allow for tolerance in fit to avoid the downturned edge of the tile making any contact with valley surface.

i For tips on cutting and bending tiles, see back of this guide

27. CREATING AN INFILL PIECE

At hips and valleys you will sometimes find that the tile you are about to cut is too small to provide sufficient coverage.

To solve this problem it's often useful to replace the last full tile (i.e. the tile next to the tile you are about to cut) with an infill piece of tile.

The image below shows the variety of infill piece you can cut from a Robust Plus tile. Each infill piece has an interlocking channel to the left and the right of it which will interlock with other Robust Plus tiles.

For best appearance when fitting an infill piece lap the cut edge of the infill piece underneath the tile next to it.

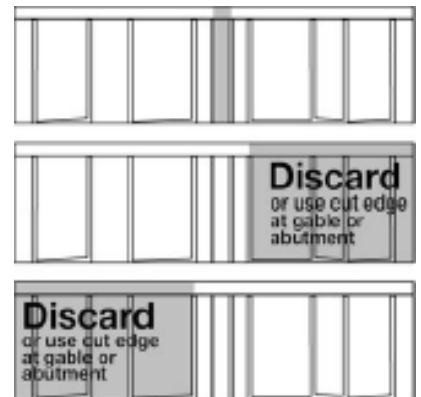

AeroDek Robust Plus

Tool Assembly

Instructions

OUR CONTACT DETAILS

If there is anything in this guide that you do not understand or that is unclear to you please do not hesitate to contact us on;

Web: <https://redland.co.uk/products/metal-tile-range>

Tel: 0330 1234585 or

E: technical.redland@bmgigroup.com

AERODEK BENDER

Assembly

Put foot on treadle (C) and apply pressure, rotate treadle release catch (B) 90° clockwise to open position.

Foot treadle (C) should be in line with front legs of frame, when jaws (D) are closed. Alignment can be changed by adjusting nuts on bolts (E).

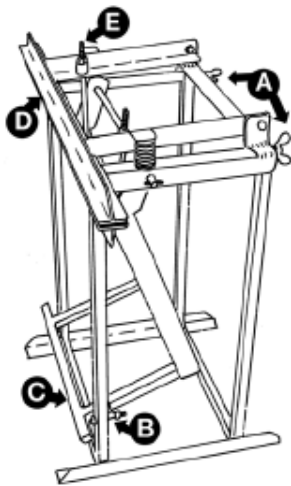

Bender Key

- (A) Full-width bender attachment bolts
- (B) Treadle release catch
- (C) Treadle
- (D) Bender jaws
- (E) Jaw adjustment bolts

AERODEK BENDER ATTACHMENT

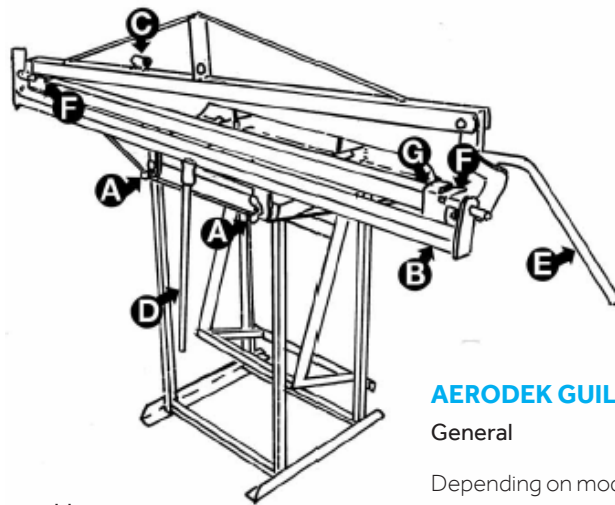

Assembly

1. Locate holes in lower frame (A) onto bolts at rear of bender and secure with wing nuts.
2. Unlock bending beam (B) from travelling position by sliding to left and downwards.
3. Unscrew handle (D) from stowage position (C) and screw into socket on bending beam.

Operation

Position tile with edges under guide lips (F) and lock jaws shut with handle (E), before bending. A spacer (G) is provided for use with Robust Plus tiles.

Bender Attachment Key

- (A) Attachment holes
- (B) Bending beam
- (C) Bending beam handle stowage position
- (D) Bending beam handle
- (E) Jaw operating handle
- (F) Tile edge guide lips
- (G) Spacer for Robust Plus tile

AERODEK GUILLOTINE

General

Depending on model, guillotine may be supplied dismantled. In this case insert 'A' frames in sockets in underside of guillotine body and secure by tightening wingnuts.

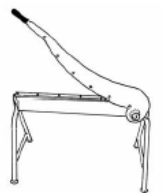

AERODEK ROOF SYSTEM: REMEMBER SAFETY

- Safety first
- Never leave a guillotine unattended with a blade up
- Always wear a safety helmet
- Always wear soft-soled safety shoes
- Always work from a safe platform or use a safety harness
- Always ensure tools are set up correctly and are regularly maintained
- Use tools safely
- It is advisable to wear gloves to protect hands from any sharp edges

AeroDek Installation Tips & Techniques

(A) USING THE GUILLOTINE

(applies to all AeroDek tile profiles except AeroDek Tradition Plus 0.9)

Operation

1. Stand facing guillotine and operate by pulling handle forward.
2. Always place tile face up (i.e. granulated side) in guillotine.
3. Cross-tile cuts should always be made with lowest point of the tile pan to the operator's left of guillotine blade. If necessary turn tile around to achieve this (see below).

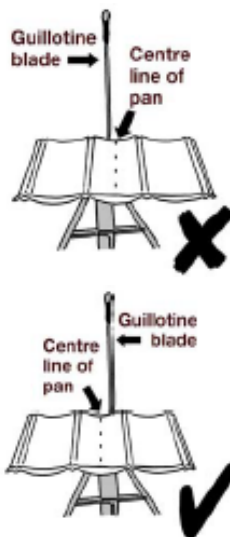

4. Nip edge of the tile closest to blade hinge flat before commencing cut.
5. Cross-tile cuts should be made before bending tile.

Longitudinal (full width) cuts should be made after bending.

Do not use the guillotine for cutting small pieces where the hands could be close to the blade.

Always ensure that the work piece is firmly held when cutting and bending AeroDek products. Only one person should use the equipment so that risk of finger entrapment or injury is minimised.

(B) CUTTING TIPS

If the guillotine does not have a smooth cutting action

AeroDek's guillotine should have an easy, smooth cutting action when cutting a tile. If it feels like you are having to make too much effort while cutting, or if it feels like the guillotine blade is dragging, there is an easy solution to improving performance. Just wipe and clean the blade with an oily rag (3 in 1 oil or any other light oil will do as you do not leave too much oil residue on the blade).

If the guillotine has been left out in the rain on site you may find light corrosion marks on the blade. Clean these off with a wire brush or wire wool and once again wipe and clean the blade with an oily rag.

Dealing with the tile scuff while using a reciprocating saw

If you find the sole plate of your reciprocating saw is making undesirable scuff marks on the top face of the tile. Flip the tile over and using a black marker pen mark your cut line on the back of the tile and then cut from the back.

(C) FORMING A TOP COURSE OF TILES

(applies to all AeroDek tile profiles except AeroDek Tradition Plus 0.9)

Insert and locate the tile

1. Position tile into the bender attachment.



2. Tile should be offered into locating tabs of bender attachment.

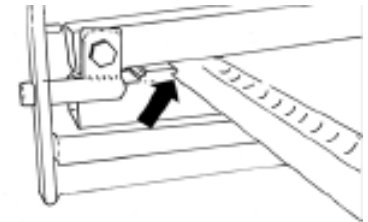

3. Ensure you locate other end of the tile to adjustable tab (see black arrow). Lift lever arm up to lock jaws if bender attachment (see grey arrow).

Bending technique

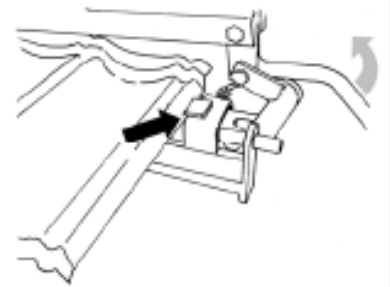

4. Set the bender by tilting the bender away from operators body, whilst supporting with left are (for right-handed people). With other hand take hold of handle ready to control bending process.



5. Lock lever arm to operator's side and allow bender to rotate gently towards operator.



- As the bender comes to ground level extend sweep of arm controlling the lever.



Raise lever to extent of sweep action to create full upturn bend. The operator's arm is extending to control unit and bend of the tile. Lever in full sweep position of bent tile.

Unlock the tile

- Carefully grip tile and pull tile out of locating tab. Slide tile right and lift bent tile out and away from bender.

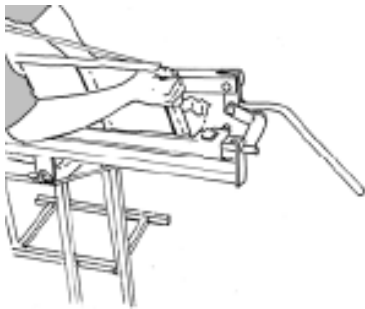

(D) FORMING A SIDE UPSTAND

(applies to all AeroDek tile profiles)

Bending preparation

- First, flatten downturn of tile at front corner. Some distortion will occur with flattening process, this is normal. Repeat process for rear corner of tile.



Bending

- Offer the tile into the jaws of bender using fingers as stop guide for size of upturn.

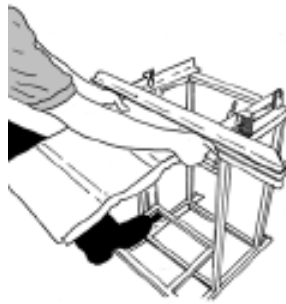

- Keeping fingers clear of vice jaws apply controlled pressure foot to peddle bar. Jaws will then clamp tile.
- With tile held by jaws of bender hold pressure in peddle and prepare to bend tile.
- Keeping foot pressed fully on peddle, bend tile in upward direction a full 90°, thus forming upturn.



(E) FORMING A RAKING CUT AND AN UPTURNED EDGE AT HIPS

(applies to all AeroDek tile profiles except AeroDek Tradition Plus 0.9)

(Valleys carries out in similar procedure)

Marking out

- Once measurements taken for hip tile transfer measurements and mark onto tile with scribe using batten as a guide.

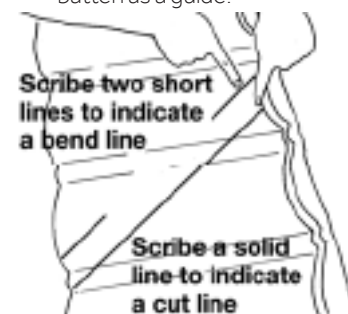

- Allow for upturn distance to suit requirements. Remember continuous line is cutting line two short lines are bending reference lines.

Cutting

- Tilt tile to suit bed of guillotine as shown. (Don't put fingers close to cutting blade)



- The portion of required tile is held by the left hand. Waste tile falls to the right of blade when viewed from operators position.
- Apply controlled pressure to blade and with left hand control guide of tile against cutting blade.

Bending preparation

- Offer tile to bender to flatten rear upturn and front downturn.

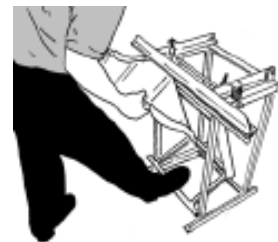

- First, flatten front downturn of tile at front corner. By positioning front downturn into jaws of bender and applying pressure to peddle to flatten. Some distortion will occur with flattening process, this is normal.
- Repeat the same flattening procedure for rear upturn.

Bending upturn

- Then offer tile to scribed bending lines.

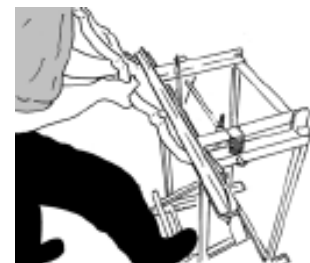

- Apply pressure to bending jaws by foot peddle.
- Start to bend tile in upward direction.
- Bend tile upwards through full 90° to form upturn.

(F) BENDING TIPS (GENERAL)

How to bend very small bend in a small work piece

It is possible to make very small bends in a small work piece of tile or tile accessory.

Tips on how to do it

1. Tuck a bit of timber under your work piece and pinch it with your thumbs against the work piece (see image below). This will allow you to maintain sufficient grip and leverage when bending.
2. Don't try to bend the full length of your work piece in one go. By bending a smaller bend than needed and then moving the work piece along in the bender and bending again it's possible to bend very small bends at quite awkward angles.

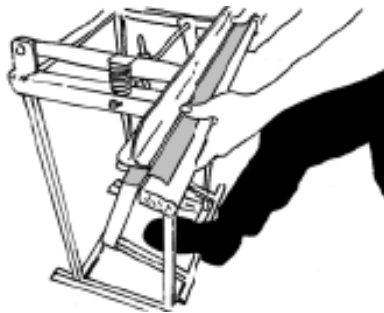

Dealing with tile scuff while bending

If you find the tile bender is making undesirable scuff marks on the top face of the tile, when bending the tiles at the valleys. Cut two thin strips of wood (50mm x 6mm or 2" x 1/4") and then tape them to the internal jaws of the bender. This will stop the tile slipping and causing scuffing when bending.

Tile slips whilst bending small work piece items for details

See "How to bend very small bends in a small work piece" and "Dealing with tile scuff while bending"

Having problems bending and forming small work piece details?

If you are new to AeroDek bending and forming small details (for example ridge intersection and mitres) can seem tricky to do.

Rather than having several attempts using AeroDek's steel components and wasting time and money, it's often a good idea to use a piece of cardboard to have a go first. Cut lines, fold lines and tabs can easily be marked out and

formed on cardboard and it's much quicker to learn how to form your detail. Even better still this piece of cardboard can then be used as a template to mark out on the AeroDek components.

(G) MAINTENANCE PROCEDURES FOR THE REMOVAL IF TILE DEFORMATIONS OR DENTS (NAIL FIXED)

To remove light to medium dents without pronounced creasing in tile:

Remove nails from front of deformed tile and to adjacent nails to tiles each side, allowing front edge of tile to be raised.



Tile nails are removed by using a carpenter's nail puller or similar behind the nail head. When levering nails from front edge of tile, place a piece of batten between head of nail puller and tile surface, to enable maximum leverage to be applied and to prevent further damage or scuffing occurring.



Lift unfastened front edge of deformed tile and slide shaft of a hammer under location of dent (shaft of hammer will form a lever against underlying tile batten). Push down on front edge of tile and hammer head until dent of tile pops back into correct position.



Install new AeroDek nails in the same positions as those removed earlier. In the event of nail holes in adjacent tiles being exposed, after fixing new tiles, these should have an AeroDek finishing kit applied to seal the holes, as should any scuff marks on tiles.

NOTE: Heavily dented or creased tiles may need complete replacement.

(H) LOST DRILL SCREW BIT

If you are screw fixing the tiles and have lost your drill screw bit a 1/4" screw driver bit holder will fit the AeroDek screws.

(J) AERODEK ROOF SYSTEM; REMEMBER SAFETY

- Safety first
- Never leave a guillotine unattended with the blade up
- Always wear a safety helmet
- Always wear soft-soled safety shoes
- Always work from a safe platform or use a safety harness
- Always ensure tools are set up correctly and are regularly maintained
- Use tools safely
- It is advisable to wear gloves to protect hands from any sharp edges