

AeroDek Tradition Plus 0.9 Tile

Secured by Design Installation Instructions

IMPORTANT NOTE

These installation instructions relate to projects that are to be installed to the Secured by Design, Police preferred specification.

To achieve this performance the standard AeroDek installation procedures have been modified and enhanced to incorporate the additional requirements in achieving the compulsory security of fittings detailing techniques.



OUR CONTACT DETAILS

The Code of practice for noise and If there is anything in this guide that you do not understand or that is unclear to you you please do not hesitate to contact us on Tel: 0330 12345 85 or E: technical.redland@bmigroup.com

1. SAFETY

These instructions are illustrative only. For the sake of clarity, access equipment which should always be erected in accordance with safety regulations, has been omitted, as have safety helmets, roofing felt and sarking boards.

2. YOU NEED

- Pencil
- Tape measure or ruler
- Tin snips
- AeroDek hand nails or AeroDek screws

You must only use fixing nails and screws supplied by AeroDek otherwise the AeroDek guarantee is invalidated

AeroDek roofing felt or breather membranes.

- Soft soled safety shoes
- Safety helmet

03. YOU ALSO NEED

- To cut the tiles and accessories you need;
- A reciprocating saw or jigsaw fitted with an appropriate cutting blade
- Edge details to the perimeters of the roof
- AeroDek tile bender

IMPORTANT - Operatives are reminded to take all due care when handling sharp edges and using tools

04. SETTING OUT THE FASCIA BOARDS AT EAVES

The positioning of the fascia board at the eaves is crucial to the success of the installation.

The fascia board must be set at the right height, set too low the tiles will dive, set too high the tiles will kick up at the wrong angle. The top edge of the fascia board should be set at the same height as the tile battens.

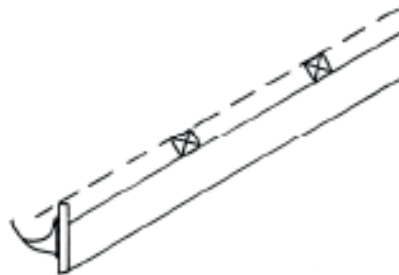

However if you are installing fascia mounted eave ventilators or AeroDek eaves guard your fascia board may need to be set lower. (refer to the instructions supplied in the AeroDek ventilation pack and AeroDek eaves guard pack).

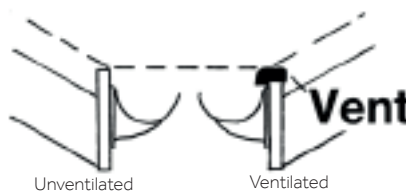

05. BATTENING

The most crucial factor in laying tiles is the accurate setting out of the tile battens, if you are not accurate then the tiles will not fit together properly.

Time spent taking extra care when battening is time saved when tiling.

BATTEN SIZES

Rafter Centre (mm)	Batten Size (recommended)
450	38 x 25 mm
600	50 x 25mm
900	50 x 50 mm
1200	50 x 50 mm

06. SETTING OUT THE BATTENS AT EAVES

The positioning of the first batten at the eaves is crucial to the success of the installation.

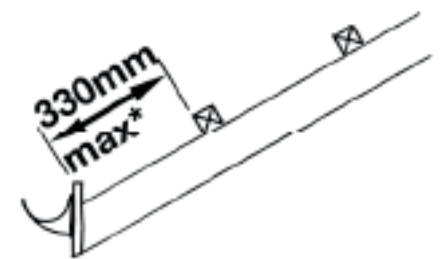

* The first tile batten should be placed in a position to suit the roof pitch and or type of gutter, typically this is 330mm from the front edge of the first tile batten.

However if you are installing fascia mounted eaves ventilators refer to the instruction supplied in the AeroDek ventilation pack.

07. BATTENING THE ROOF

Then fix the other battens working from the bottom of the rafter.

At 368mm spacings from front lower face of batten to front lower face of batten.

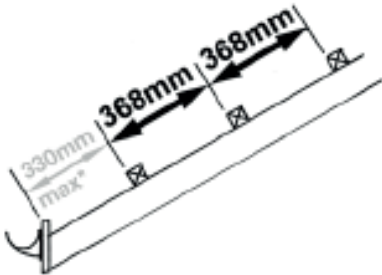

Care should be taken to be accurate when installing the battens. Time spent taking extra care when battening is time saved when tiling.

08. AERODEK EAVES GUARDS

AeroDek Eaves Guard is an eave protection system which was installed underneath the roofing underlay providing support for the underlay at eaves.

If you are installing the AeroDek Eaves Guard refer to the instructions supplied in the AeroDek Eaves Guard pack.

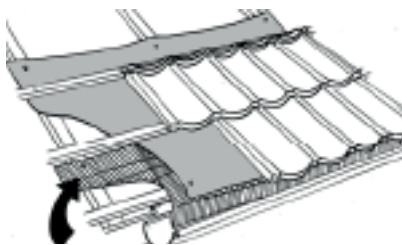

AeroDek Eaves Guard

09. SETTING OUT GABLES

Fix the barge boards in a position where they are level with the tops of the tile battens. Underlay should turn up against the edge of bargeboard by 38mm.

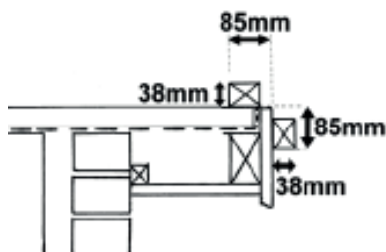

On top of the tile battens nail additional gable runner battens up the slope of the roof and along the vertical face of the bargeboard. These battens should be

set 85 mm from the outer top edge of the bargeboard (see drawing)

10. PREPARATION FOR AERODEK VENTILATION TILES (Installing the AeroDek Anti-Intruder bar)

NOTE: Where AeroDek tile ventilators are to be used, the AeroDek Anti-intruder bar must also be installed and located in a central position to the ventilator that does not foul or impede the correct installation of the vent tile.

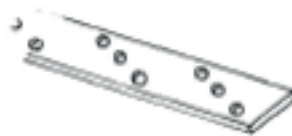

AeroDek Anti Intruder bar

Important Note: For the AeroDek Tradition Plus 0.9 tile it is not necessary to install AeroDek Anti-intruder bar to the whole roof area, only to the roof areas directly below the AeroDek tile ventilators.

Install the AeroDek Anti-intruder steel bar using 50mm x 6.0mm AeroDek Anti-intruder bar screws, using 1no screw at each intersection of the Anti-intruder bar with the rafter.

The AeroDek Anti-intruder bar must be installed directly above or below the centre point of the tile battens in a position that does not foul or impede the correct installation of the vent tile.

Where there is a need to join more than one anti-intruder bar together see below.

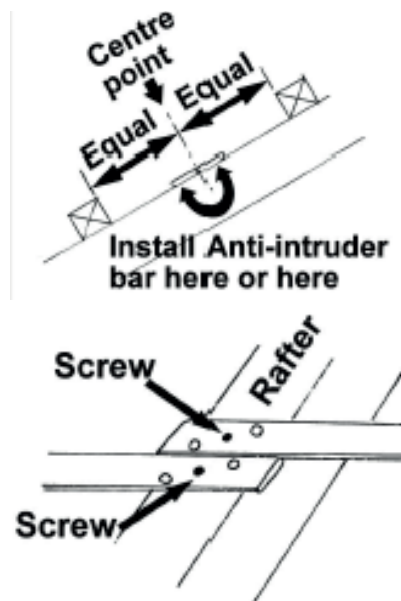

11 WALKING ON THE TILES

When walking on the roof it is strongly recommended that you should wear soft soled safety shoes to avoid any possible abrasion to the surface coating.

Your weight should be concentrated over the front edge and in the pan of tiles, as this is the area supported by battens. Weight should not be applied to the raised crown of the profile on the middle tiles. **If you have managed to dent a tile refer to the tip section in the back of this guide.**

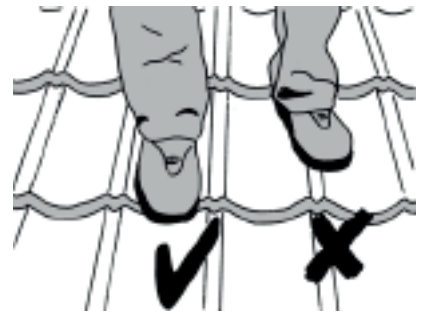

12. START LAYING THE TILES

Lay the tiles starting at the batten below the ridge. **When putting your first nails in take care not to puncture the underlay below.**

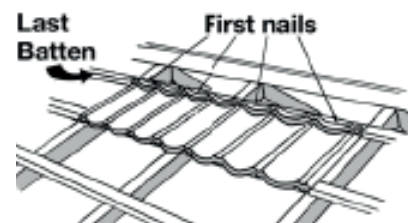

Why lay from the top?

Although this is the opposite of traditional tiling practice, by laying from the top the tiles interlock together and it is actually quicker to lay the tiles this way.

Do I lay the tiles straight bond or staggered bond?

The choice is yours, if you are refitting a straightforward Gable to Gable roof then straight bond is the quickest way to do it but for best appearance lay the laps away from the principle line of sight of the building. if you are roofing a hipped or valley roof then you will find that it's quicker to lay the tiles broken bond working away from the hip and valley.

Starting from a gable end?

Then don't forget you may need to allow for an appropriate upstand at the gable end of the tile (see Gable sections).

How much side lap?

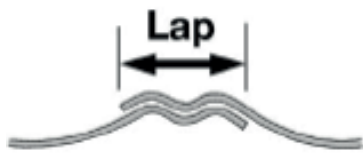

Which direction should I lap the tiles?

AeroDek tiles can be laid from left to right or right to left but for best appearance lay laps away from the principle line of sight.

13. WHEN YOU HAVE LAID SEVERAL COURSES

AeroDek Tradition Plus 0.9 tiles are twice the thickness of standard AeroDek tiles so a nail punch is needed to get you started.

When you have laid several courses (laying them one under the other, by lifting the nose of a tile and tucking the next time under) start pre-punching the tiles using a nail punch and then nail with AeroDek Tradition Plus 0.9 nails, 7 per tile, laps and every other pan.

Nail tiles through the nose as shown in the sketches, leaving the bottom course loose until more tiles are laid.

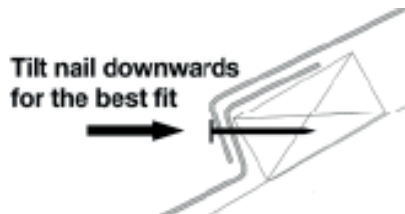

i You must only use fixing nails and screws to supplied by AeroDek otherwise the AeroDek guarantee is invalidated.

14. NAIL THE EAVES COURSE

Nail the eaves course 10 mm from the high point of the pan into the top of the fascia or eaves batten (if eaves ventilation is being fitted, see ventilation pack for nail positions).

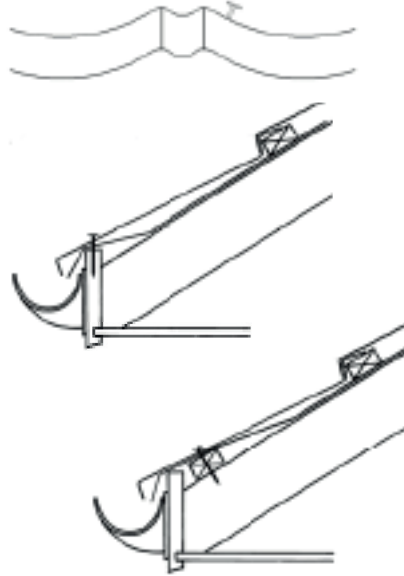

Use 7 nails per tile. After completion of roof, cover these nail heads with AeroDek finishing kit.

15. GABLES

The gable detail is finished using an AeroDek D Box Barge Cap. The D Ridge in appearance but the angle is much steeper (see below).



AeroDek tiles to be cut and bent forming an upstand against a gable runner batten.

Before installing the first D Box Barge Cap it is necessary to trim and fold the ends to form a blocked end at the eaves. Marks out a line 40mm from the bottom edge of D Box Barge Cap. Cut away areas shaded black in image below. Fold vertical flap 90°.



The D Box Barge Caps have a slight taper to their design. Place the wider end of the D Box Barge Cap over the narrower top end of the D Box Barge Cap beneath creating an 80mm overlap.

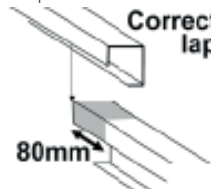

Nail D Box Barge Cap into position using 6 nails skew fixed down the inner face of the D Box Barge Cap into the upstand of the tile and 6 horizontally (see images below). Care should be taken to ensure D Box Barge Cap are correctly lapped.

6 no nails skew fixed through barge cap into the upstand of the tile, nails spaced evenly apart at approx 200mm centres

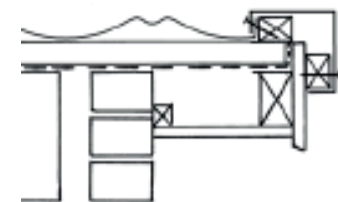
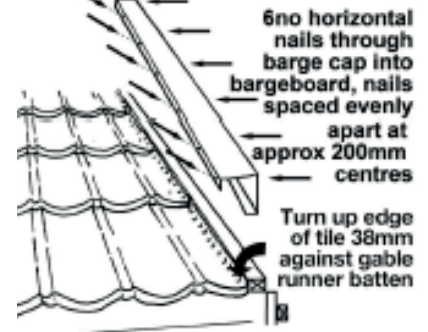

16. RIDGE COURSE D RIDGE

The correct way to install the top course of tiles and the ridge tiles is determined by whether you are trying to achieve an unventilated or ventilated ridge detail.



Universal ridge ventilator

17 RIDGE COURSE NAILING & LAPPING D RIDGES

The ridge caps have a slight taper in their design. Place the wider end of the ridge over the narrower end of the ridge beneath creating an 80mm overlap.

Each ridge should be secured with 6 nails on each side of the ridge cap. The nails must be evenly spaced apart at approximately 200mm centres.

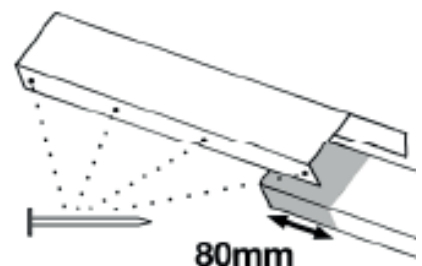

18. RIDGE COURSE D RIDGE (UNVENTILATED)

Fit two tile battens either side of the ridge. Cut top tiles to suit (leaving a 10mm gap between the top cut edge of the tile and the top cut edge of the tile on the other side of the ridgeline).

Fix additional 50mm x 25mm batten to suit D Ridge on top of the tiles taking care to sandwich the D Ridge Sealing Strip between the batten and the tile.

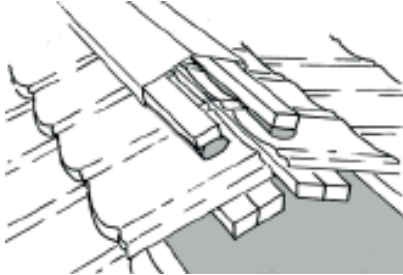

i For tips on cutting tiles see back of this guide.

19. RIDGE COURSE D RIDGE WITH UNIVERSAL D RIDGE VENT



Universal ridge ventilator

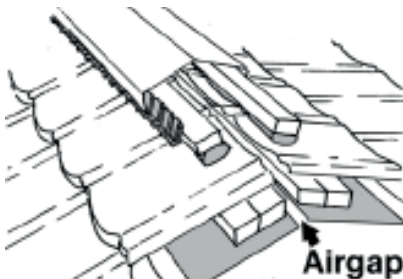

Cut underlay short of ridge line and fit two tile battens either side of ridge leaving a sufficient gap for ventilation.

Fit two tile battens either side of ridge.

Cut top tiles to suit (leaving a 10mm gap between the top cut edge of the tile and the top cut edge of the tile on the other side of the ridgeline).

Fix additional 50mm x 25mm batten to suit D Ridge on top of the tiles, taking care to sandwich the D ridge sealing strip between the batten and the tile.

Place ridge cap into position over the top batten and the upstand edge of the tile. Pull bottom edge of ridge cap away from the upstand edge of tile and slip Universal D Ridge/hip ventilators into position on each side of the D Ridge Cap. Ventilators should run continuously along each side of the ridge cap.

The ridge cap and ventilator to be nailed through the downturn of the ridge cap into the face of the batten using six AeroDek fixing nails on each side.

i For tips on cutting tiles see back of this guide.

20. D RIDGE END CAPS

(available in standard 0.43mm gauge only)

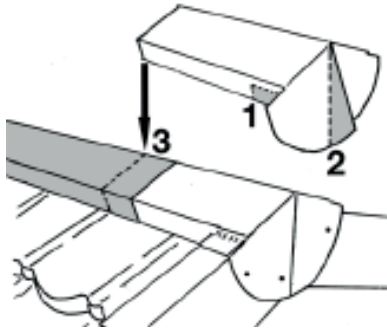

1. Snip and fold out flap to suit barge cover.
2. Trim edge of flap to create a vertical plumbline when fitted.
3. Install D Ridges over end of D Ridge End Cap ensuring a good tight lap occurs. Then nail D Ridge End Cap into position (fix vertical end of D Ridge Cap first).

21. MONO-PITCH D RIDGE

Mono-pitch ridge caps can be formed by adjusting the angles of AeroDek standard 0.43mm D Ridge Cap.



The procedure for installing the mono-pitch ridge is essentially the same as the detail for the ridges (please refer to ridge instruction shown earlier in this guide).

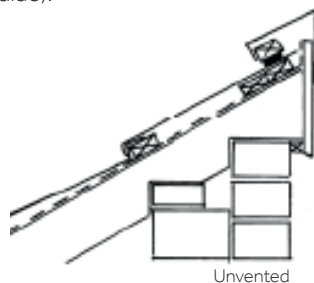

Unvented

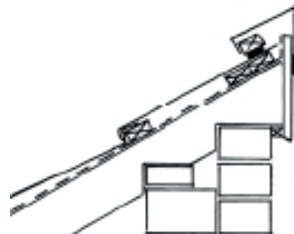

Vented using a Universal D Ridge Vent*

*When fitting the two tile battens at the top remember to leave a sufficient gap for ventilation.

*When fitting the D Ridge ensure that a gap of at least 5mm is maintained between the underside of the ridge and the topmost batten.

i For tips on cutting tiles see back of this guide.

22. TOP EDGE ABUTMENT

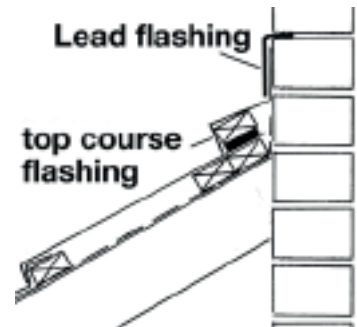

Unvented

Turn roofing underlay 75mm up the abutment wall.

Cut top tiles to suit. Fix additional 50mm x 25mm batten to suit AeroDek Top Course flashing on top of the tiles, taking care to sandwich the sealing strip between the batten and the tile.

Each AeroDek top course flashing should be secured with 6 nails driven through the downturned front edge into the underlying tile batten. The nails must be evenly spaced apart at approximately 200mm centres.

Cover over with a lead flashing.

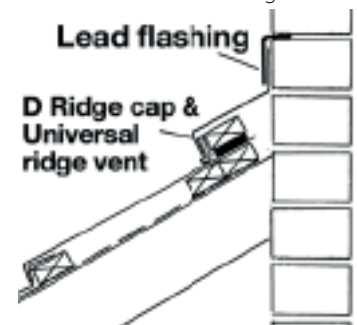

Vented with a Universal D Ridge Vent Filler

An appropriate top course flashing for use with an AeroDek Universal D ridge ventilator can be formed using an AeroDek Top Course flashing (by adjusting its downturned edge) or alternatively by adjusting the angles of a standard AeroDek D Ridge cap. When fitting the top course flashing ensure

that a gap of at least 5mm is maintained between the underside of the top course flashing and the topmost batten. (When fitting the two tile battens at the top remember to leave a sufficient gap for ventilation)

Each AeroDek top course flashing should be secured with 6 nails driven through the downturned front edge into the underlying tile batten. The nails must be evenly spaced apart at approximately 200mm centres.

(info symbol) For tips on cutting tiles, see back of this guide

i For tips on cutting tiles see back of this guide.

23. SIDE EDGE ABUTMENT

Turn the tile and roofing underlay 75mm up the abutment wall and cover over with a lead flashing.

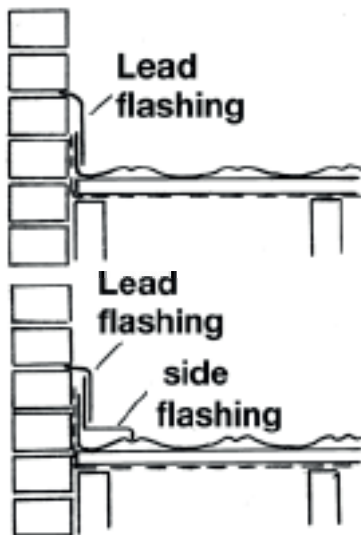

24. HIPS

Install tile battens to suit gauge of tiles, ensure that tile battens project to centre line of hip tree.

Step 1 Measuring for the Hip Tile

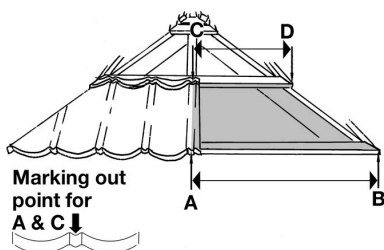

Measure from point (A) to (B). Measure from point (C) to (D) write down these measurements minus 5 mm off both distances, this will be the set distance to make your cut at.

Step 2, Marking out your Hip Tile

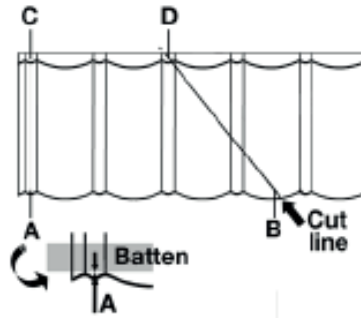

Markout the same measurement (A) to (B) and (C) to (D) on a tile when transferring measurements to tile ensure measurements correspond with the position of the underlying tile batten (see batten intersection drawing below).



Scribe a line from (B) to (D), this will be the cutting point of your hip tile

Step 3, Cut your hip tile

See tips on cutting tiles at the back of this guide.

Step 4, Install your hip tile ensuring that the next tile laps over it.

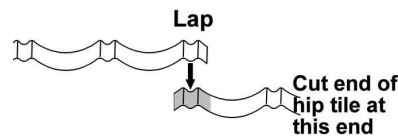

Step 5, Install ridge cap to hip

The methods for installing AeroDek D ridges with or without Universal D Ridge ventilators is the same in principle as shown for the ridge detailing earlier in this guide.

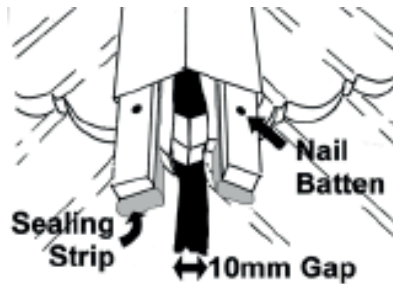

NOTE: When installing the D Ridge hip/ Sealing Strip make a neat incision at each intersection of the sealing strip with the nose of the tile to allow the sealing strip to dress fully into the step between each course of the tiles.

i For tips on cutting tiles see back of this guide

25. FORMING A THREE WAY INTERSECTION AT HIPS

To form a three way intersection using D Ridges cut and fold tabs and flaps in ridge tiles as shown ridge sections A, B and C above. Install ridge section A followed by ridge section B then C on top. Nail ridge caps into position and touch up with AeroDek finishing kit.

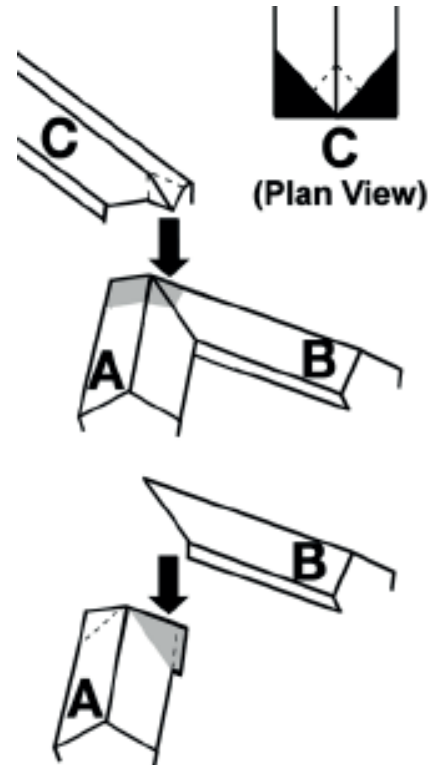

26. VALLEYS

Lay valley boards flush with rafter level and install valley runner batten to each side of valley.

If needed, install an additional packer batten parallel to side of valley runner batten, so as to support sweep of tile batten.



Install tile battens to suit gauge of tiles, ensure that tile battens sweep up and over valley runner batten. Cut battens to rake projecting over valley 65mm short of centre line of valley.

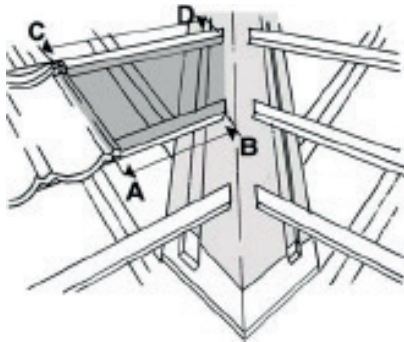

Step 1, Measuring for the Valley Tile

Measure from point (A) to (B), measure from point (C) to (D), write down these measurements as this will be the set distance to make your bend at

Step 2, Marking out your Valley Tile

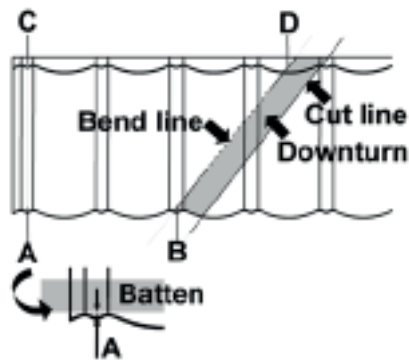

Mark out the same measurement (A) to (B), (C) and (D) to a tile. When transferring measurements to tile ensure measurement corresponds with the position underlying tile batten (see batten intersection drawing below).

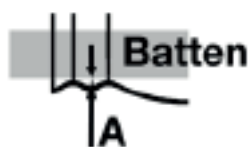

Scribe a line from (B) to (D) this will be the bending point for your valley tile.

Scribe an additional cut line onto the tile to allow for a tile downturn at the valley.

NOTE: When performing a downturn in the tile take a measurement from the top leading edge of the tile batten to valley surface and allow for tolerance in fit to avoid the downturned edge of the tile making any contact with valley surface.

Step 3, Cut and bend your valley tile

Cut and bend the valley tile and fix into position (see tips on cutting and bending tiles at the back of this guide)

Remember when you install your valley tile, ensuring that the next tile laps over it and not under it.

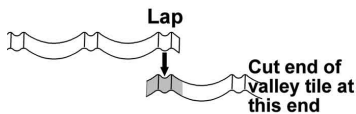
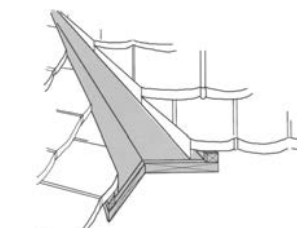

27. VENTILATION TILES

NOTE: Where AeroDek tile ventilators are to be used, the AeroDek Anti-intruder bar must also be installed and located in a central position that does not foul or impede the correct installation of the vent tile (see 'installing the AeroDek Anti-intruder bar' section earlier in this guide)

1. Locate the position of the Tile Vent extension pipe on the underlay.
2. Remove Tile Vent and cut underlay, folding flaps upwards and outwards.

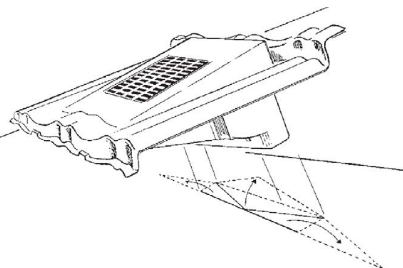

3. Cut a 340mm horizontal slit about 100mm above the opening created and place flat end of Opening Protector into the slit and locate the upstand end above the opening in the underlay.

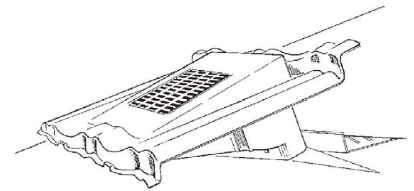

4. Fit Tile Vent following normal Secured By Design AeroDek tiling procedure.
5. Insert the extension spigot into the roof space, ensuring the three underlay flaps are facing upwards.
6. Fix the Tile Vent into position by overlapping a standard AeroDek Tile on either side and nailing through the nose of the tiles immediately adjacent to the Vent. Do not nail through the nose or upstand of the Vent.

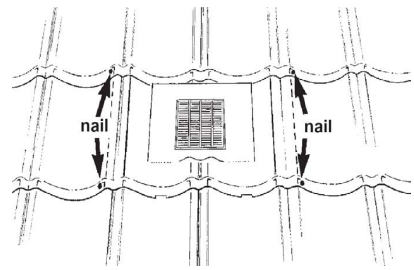

7. For high level ventilation the Tile Vents should be installed on the second course down from the ridge or top edge at the recommended centres.
8. For soil or mechanical extract fit the Pipe Adaptor and then the Flexible Extension Hose from the Pipe Adaptor to the soil or mechanical extraction stack using jubilee clips provided.

Note: Tile Vents must not be used as exit terminals or hot combustion gases.

Contents:

1 Tile Vent, 1 Opening Protector.

Flexible Extension Hoses and Adaptors are supplied separately.

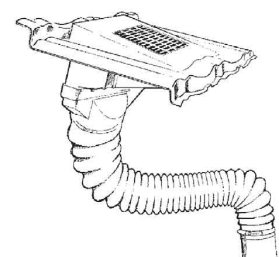

AeroDek Tradition Plus 09 Tool Assembly Instructions

AERODEK BENDER

Assembly

Put foot on treadle (c) and apply pressure, rotate treadle release catch (B) 90° clockwise to open position.

Foot treadle (C) should be in line with front legs of frame, when jaws (D) are closed. Alignment can be changed by adjusting nuts on bolts (E).

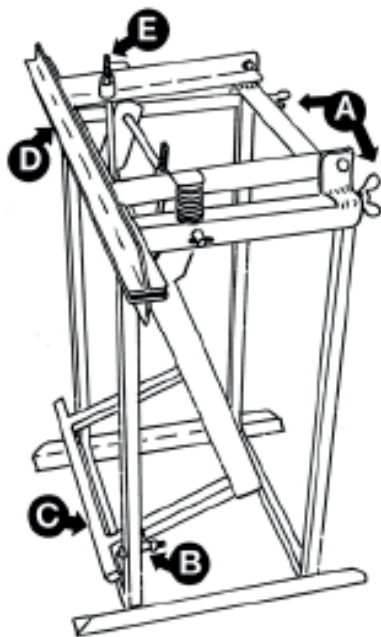

Bender Key

- (A) Full-width bender attachment bolts
- (B) Treadle release catch
- (C) Treadle
- (D) Bender jaws
- (E) Jaw adjustment bolts

AERODEK TRADITION PLUS 0.9 TILE CLAMP

General

The AeroDek Tradition Plus 0.9 Tile Clamp has been designed to hold a tile safely in place while it is being cut.

Assembly

The tile clamp should arrive on site to you pre-assembled, however if for any reason the nuts and bolts have come loose there is an illustration of its assembly below.

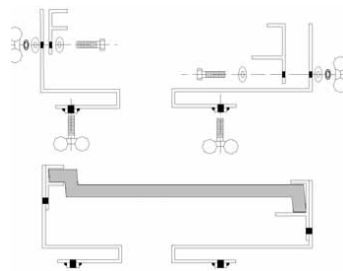

The full assembled tile clamp should be mounted onto the top platform of an appropriate work bench (i.e Black & Decker Workmate etc) and secured in place with the wingnuts bolts.

Operation

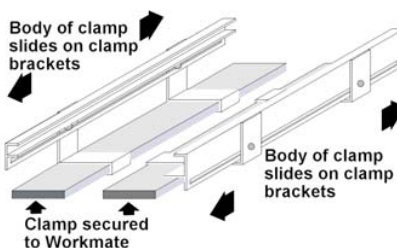

Operation

Position tile with edges under guide lips of tile clamp and adjust jaws of workmate to clamp tile firmly in position.



Cut the tile as appropriate with a reciprocating saw.

OUR CONTACT DETAILS

If there is anything in this guide that you do not understand or that is unclear to you please do not hesitate to contact us on;

Web: www.aerodek.com/uk

Tel: 0330 12345 85 or

E: technical.redland@bmggroup.com

AERODEK ROOF SYSTEM: REMEMBER SAFETY

- Safety first
- Never leave a guillotine unattended with a blade up
- Always wear a safety helmet
- Always wear soft-soled safety shoes
- Always work from a safe platform or use a safety harness
- Always ensure tools are set up correctly and are regularly maintained
- Use tools safely
- It is advisable to wear gloves to protect hands from any sharp edges

AeroDek Installation Tips & Techniques

(A) USING THE GUILLOTINE

(applies to all AeroDek tile profiles
except AeroDek Tradition Plus 0.9)

Operation

1. Stand facing guillotine and operate by pulling handle forward.
2. Always place tile face up (i.e. granulated side) in guillotine.
3. Cross-tile cuts should always be made with lowest point of the tile pan to the operator's left of guillotine blade. If necessary turn tile around to achieve this (see below).

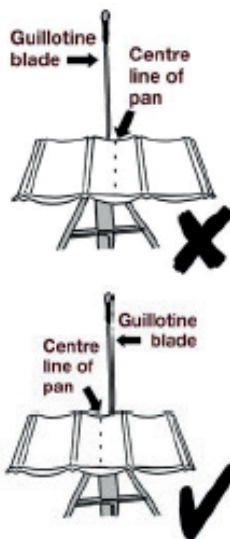

4. Nip edge of the tile closest to blade hinge flat before commencing cut.
5. Cross-tile cuts should be made before bending tile.

Longitudinal (full width) cuts should be made after bending.

Do not use the guillotine for cutting small pieces where the hands could be close to the blade.

Always ensure that the work piece is firmly held when cutting and bending AeroDek products. Only one person should use the equipment so that risk of finger entrapment or injury is minimised.

(B) CUTTING TIPS

If the guillotine does not have a smooth cutting action

AeroDek's guillotine should have an easy, smooth cutting action when cutting a tile. If it feels like you are having to make too much effort while cutting, or if it feels like the guillotine blade is dragging, there is an easy solution to improving performance. Just wipe and clean the blade with an oily rag (3 in 1 oil or any other light oil will do as you do not leave too much oil residue on the blade).

If the guillotine has been left out in the rain on site you may find light corrosion marks on the blade. Clean these off with a wire brush or wire wool and once again wipe and clean the blade with an oily rag.

Dealing with the tile scuff while using a reciprocating saw

If you find the sole plate of your reciprocating saw is making undesirable scuff marks on the top face of the tile. Flip the tile over and using a black marker pen mark your cut line on the back of the tile and then cut from the back.

(C) FORMING A TOP COURSE OF TILES

(applies to all AeroDek tile profiles
except AeroDek Tradition Plus 0.9)

Insert and locate the tile

1. Position tile into the bender attachment.



2. Tile should be offered into locating tabs of bender attachment.

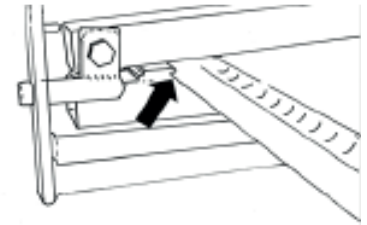

3. Ensure you locate other end of the tile to adjustable tab (see black arrow). Lift lever arm up to lock jaws if bender attachment (see grey arrow).

Bending technique

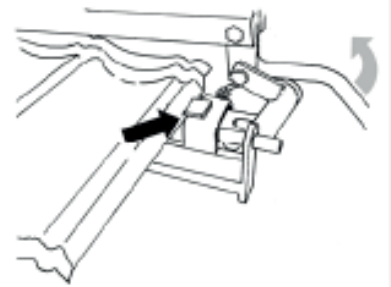

4. Set the Bender by tilting the bender away from operators body, whilst supporting with left are (for right-handed people). With other hand take hold of handle ready to control bending process.

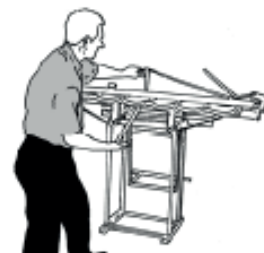

5. Lock lever arm to operator's side and allow bender to rotate gently towards operator.



- As the bender comes to ground level extend sweep of arm controlling the lever.



Raise lever to extent of sweep action to create full upturn bend. The Operator's arm is extending to control unit and bend of the tile. Lever in full sweep position of bent tile.

Unlock the tile

- Carefully grip tile and pull tile out of locating tab. Slide tile right and lift bent tile out and away from bender.

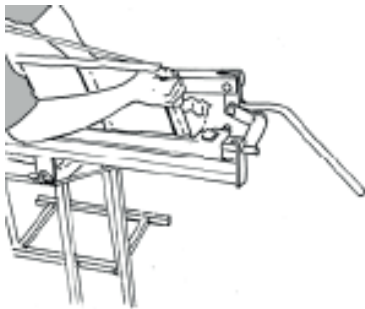

(D) FORMING A SIDE UPSTAND

(applies to all AeroDek tile profiles)

Bending preparation

- First, flatten downturn of tile at front corner. Some distortion will occur with flattening process, this is normal. Repeat process for rear corner of tile.



Bending

- Offer the tile into the jaws of bender using fingers as stop guide for size of upturn.

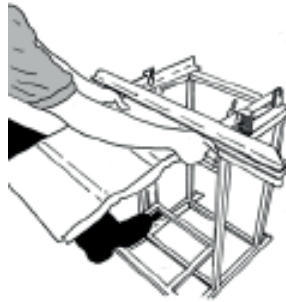

- Keeping fingers clear of vice jaws apply controlled pressure foot to peddle bar. Jaws will then clamp tile.
- With tile held by jaws of bender hold pressure in peddle and prepare to bend tile.
- Keeping foot pressed fully on peddle, bend tile in upward direction a full 90°, thus forming upturn.



(E) FORMING A RAKING CUT AND AN UPTURNED EDGE AT HIPS

(applies to all AeroDek tile profiles except AeroDek Tradition Plus 0.9)

(Valleys carries out in similar procedure)

Marking out

- Once measurements taken for hip tile transfer measurements and mark onto tile with scribe using batten as a guide.

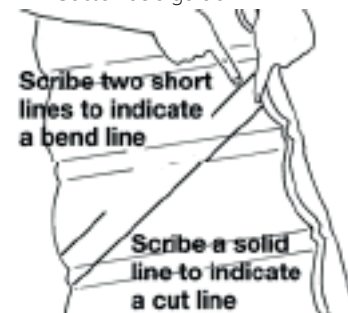

- Allow for upturn distance to suit requirements. Remember continuous line is cutting line two short lines are bending reference lines.

Cutting

- Tilt tile to suit bed of guillotine as shown. (Don't put fingers close to cutting blade)



- The portion of required tile is held by the left hand. Waste tile falls to the right of blade when viewed from operators position.
- Apply controlled pressure to blade and with left hand control guide of tile against cutting blade.

Bending preparation

- Offer tile to bender to flatten rear upturn and front downturn.



- First, flatten front downturn of tile at front corner. By positioning front downturn into jaws of bender and applying pressure to peddle to flatten. Some distortion will occur with flattening process, this is normal.
- Repeat the same flattening procedure for rear upturn.

Bending upturn

- Then offer tile to scribed bending lines.

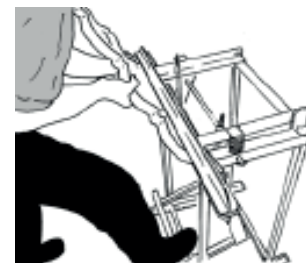

- Apply pressure to bending jaws by foot peddle.
- Start to bend tile in upward direction.
- Bend tile upwards through full 90° to form upturn.

(F) BENDING TIPS (GENERAL)

How to bend very small bend in a small work piece

It is possible to make very small bends in a small work piece of tile or tile accessory.

Tips on how to do it

1. Tuck a bit of timber under your work piece and pinch it with your thumbs against the work piece (see image below). This will allow you to maintain sufficient grip and leverage when bending.
2. Don't try to bend the full length of your work piece in one go. By bending a smaller bend than needed and then moving the work piece along in the bender and bending again it's possible to bend very small bends at quite awkward angles.

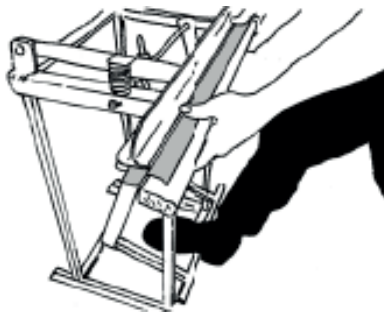

Dealing with tile scuff while bending

If you find the tile bender is making undesirable scuff marks on the top face of the tile, when bending the tiles at the valleys. Cut two thin strips of wood (50mm x 6mm or 2" x 1/4") and then tape them to the internal jaws of the bender. This will stop the tile slipping and causing scuffing when bending.

Tile slips whilst bending small work piece items for details

See "How to bend very small bends in a small work piece" and "Dealing with tile scuff while bending"

Having problems bending and forming small work piece details?

If you are new to AeroDek bending and forming small details (for example ridge intersection and mitres) can seem tricky to do.

Rather than having several attempts using AeroDek's steel components and wasting time and money, it's often a good idea to use a piece of cardboard to have a go first. Cut lines, fold lines and tabs can easily be marked out and

formed on cardboard and it's much quicker to learn how to form your detail. Even better still this piece of cardboard can then be used as a template to mark out on the AeroDek components.

(G) MAINTENANCE PROCEDURES FOR THE REMOVAL IF TILE DEFORMATIONS OR DENTS (NAIL FIXED)

To remove light to medium dents without pronounced creasing in tile:

Remove nails from front of deformed tile and to adjacent tiles to tiles each side, allowing front edge of tile to be raised.

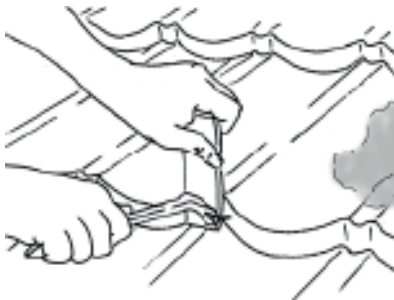

Tile nails are removed by using a carpenter's nail puller or similar behind the nail head. When levering nails from front edge of tile, place a piece of batten between head of nail puller and tile surface, to enable maximum leverage to be applied and to prevent further damage or scuffing occurring.

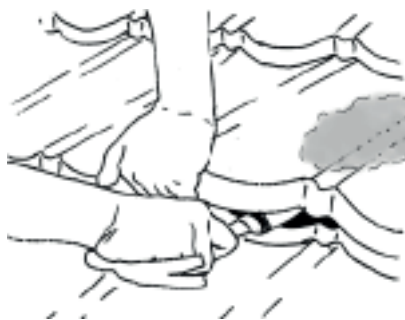

Lift unfastened front edge of deformed tile and slide shaft of a hammer under location of dent (shaft of hammer will form a lever against underlying tile batten). Push down on front edge of tile and hammer head until dent of tile pops back into correct position.



Install new AeroDek nails in the same positions as those removed earlier. In the event of nail holes in adjacent tiles being exposed, after fixing new tiles, these should have an AeroDek finishing kit applied to seal the holes, as should any scuff marks on tiles.

NOTE: Heavily dented or creased tiles may need complete replacement.

(H) LOST DRILL SCREW BIT

If you are screw fixing the tiles and have lost your drill screw bit a 1/4" screw driver bit holder will fit the AeroDek screws.

(J) AERODEK ROOF SYSTEM; REMEMBER SAFETY

- Safety first
- Never leave a guillotine unattended with the blade up
- Always wear a safety helmet
- Always wear soft-soled safety shoes
- Always work from a safe platform or use a safety harness
- Always ensure tools are set up correctly and are regularly maintained
- Use tools safely
- It is advisable to wear gloves to protect hands from any sharp edges